



# Information Packet

80th West Virginia Legislature

# 2012

## Contents

Revised: January 27, 2012 11:00 AM

State Organizational Chart	p. 3
Senate Membership Photos	p. 4
House Membership Photos	p. 5-7
Senate Membership Phone & Office Numbers	p. 8
House Membership Phone & Office Numbers	p. 9
Senate Leadership & Standing Committees	p. 10-11
House Leadership & Standing Committees	p. 12-15
Senate Chamber Seating Chart	p. 16
House Chamber Seating Chart	p. 17
Delegates by District & District Map	p. 18-19
Senators by District & District Map	p. 20
State Capitol Maps	p. 21-26
State Agencies - Toll-Free Numbers	p. 27-28
State Colleges & Universities - Toll-Free Numbers	p. 28
State Capitol Phone Numbers	p. 28
State Agencies - Web site Addresses	p. 29-30
State & National Political Org's - Web site Addresses	p. 30
State Colleges & Universities - Web site Addresses	p. 30
West Virginia Congressional Map & Contact Information	p. 31
Congressional District Map & Contact Information	p. 32-33
Legislative Calender	p. 34

---

# STATE OF WEST VIRGINIA ORGANIZATIONAL CHART

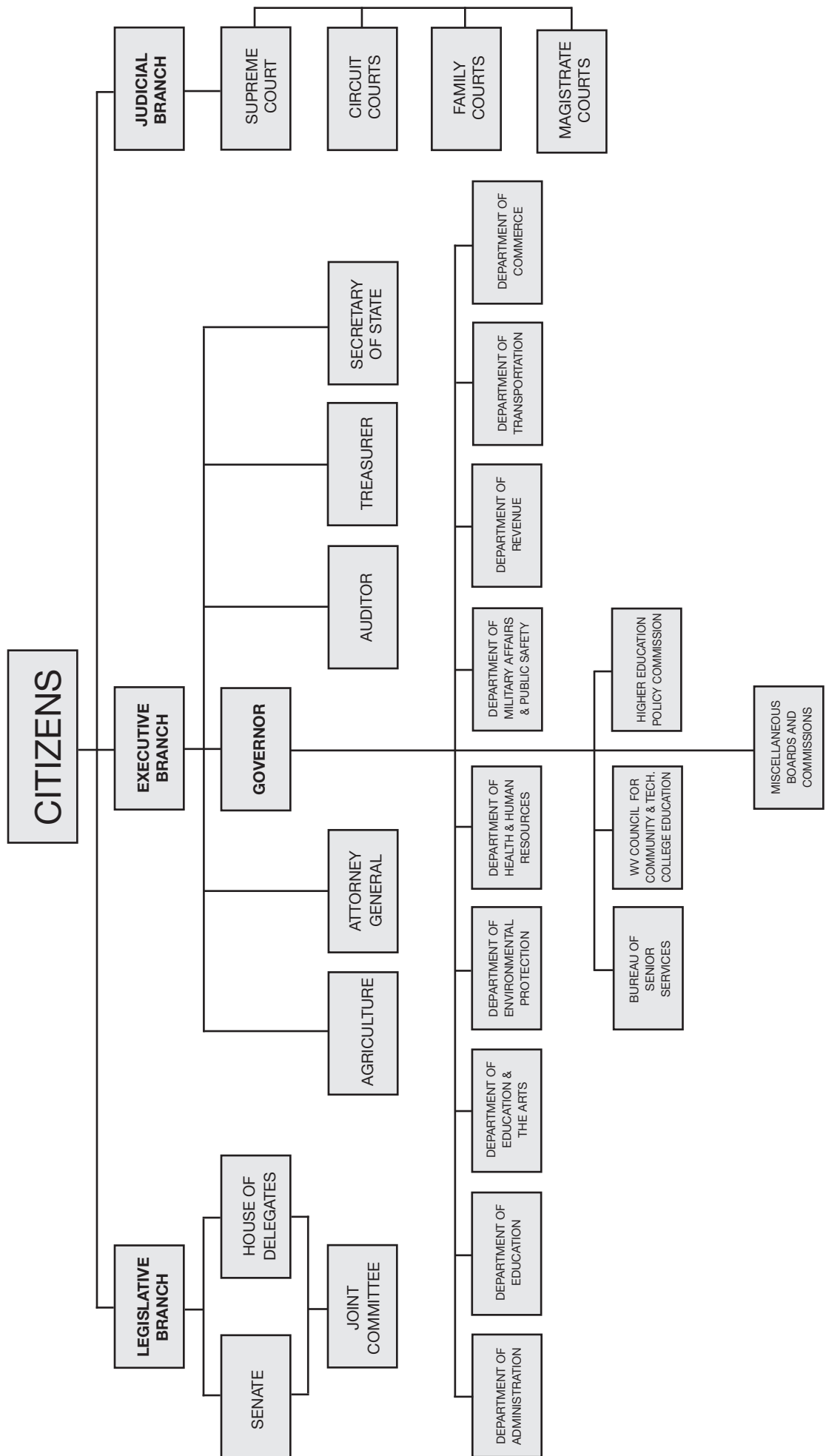



# West Virginia State Senate

## 80th Legislature - 2012



Jeffrey V. Kessler  
Senate President



Clark S. Barnes



Robert Beach



Donna J. Boley



Richard Browning



H. Truman Chafin



Larry J. Edgell



Douglas E. Facemire



Karen L. Facemyer



John Pat Fanning



Dan Foster



Mike Green



Mike Hall



Walt Helmick



Evan H. Jenkins



Art Kirkendoll



Orphy Klempa



William R. Laird IV



Brooks McCabe



Ronald Miller



Joseph M. Minard



David Nohe



Corey Palumbo



Robert H. Plymale



Roman Prezioso



Herb Snyder



Ron Stollings



Dave Sybolt



Gregory A. Tucker



John Unger



Erik Wells



Bob Williams



Mark Wills



Jack Yost



Senate Clerk  
Darrell Holmes



# West Virginia House of Delegates

## 80th Legislature - 2012

Richard Thompson  
House Speaker



Bill Anderson



Troy Andes



Tim Armstead



Bob Ashley



Tom Azinger



Anthony Barill



Larry W. Barker



Brent Boggs



Anna Border



Bonnie Brown



Greg Butcher



Denise Campbell



Thomas Campbell



Samuel J. Cann Sr.



Ray Canterbury



Mike Caputo



Mitch Carmichael



Daryl E. Cowles



Kevin J. Craig



Gerald L. Crosier



Phil Diserio



John Doyle



Walter E. Duke



John N. Ellem



Joe Ellington



Allen V. Evans



Ryan J. Ferns



Michael T. Ferro



Barbara Evans Fleischauer



Ron Fragale



John Frazier



Marty Gearheart



Roy Givens



Nancy Peoples Guthrie



Daniel J. Hall



Bill Hamilton





William Hartman



Barbara Hatfield



Eric L. Householder



Gary G. Howell



Mark Hunt



Richard J. Iaquinata



Lynwood "Woody" Ireland



Ronnie D. Jones



Larry D. Kump



Patrick Lane



Tiffany E. Lawrence



Linda Longstreth



Virginia Mahan



Tim Manchin



Mike Manypenny



Justin Marcum



Charlene Marshall



Helen Martin



Harold Michael



Tim Miley



Carol Miller



Jonathan Miller



Clif Moore



Jim Morgan



Ricky Moye



Eric Nelson



John D. O'Neal



John Overington



Amanda Pasdon

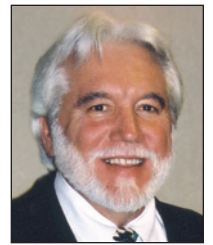

Brady Paxton



Don Perdue



David G. Perry



Dave Pethel



Linda Goode Phillips



Rupert Phillips



John Pino



Daniel Poling



Mary M. Poling



Meshea L. Poore



Doug Reynolds



Ralph Rodighiero



William R. Romine





Ruth Rowan



Brian Savilla



Stan Shaver



Harold "Pete" Sigler



Doug Skaff Jr.



Margaret D. Smith



Rick Snuffer



Kelli Sobonya



Margaret Anne Stagers



Dale Stephens



Erikka Storch

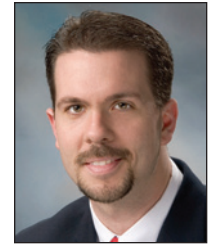

Josh Stowers



Linda Sumner



Randy Swartzmiller



Joe Talbott



Scott Varnier



David Walker



Ron Walters



Danny Wells



Harry Keith White



Larry A. Williams



**House Clerk**  
Gregory M. Gray

## Senate - Capitol Phone Numbers & Offices

**Clark S. Barnes**  
(304) 357-7973  
203W

**Robert D. Beach**  
(304) 357-7919  
204W

**Donna J. Boley**  
(304) 357-7905  
213W

**D. Richard Browning**  
(304) 357-7807  
218W

**H. Truman Chafin**  
(304) 357-7808  
441M

**Larry J. Edgell**  
(304) 357-7827  
223W

**Douglas E. Facemire**  
(304) 357-7845  
217W

**Karen L. Facemyer**  
(304) 357-7855  
257M

**John Pat Fanning**  
(304) 357-7867  
216W

**Dan Foster**  
(304) 357-7866  
223W

**Mike Green**  
(304) 357-7831  
206W

**Mike Hall**  
(304) 357-7901  
245M

**Walt Helmick**  
(304) 357-7980  
200W

**Evan H. Jenkins**  
(304) 357-7956  
216W

**Jeffrey V. Kessler**  
(304) 357-7801  
227M

**Art Kirkendoll**  
(304) 357-7857  
218W

**Orphy Klempa**  
(304) 357-7918  
204W

**William R. Laird IV**  
(304) 357-7849  
229W

**Brooks McCabe**  
(304) 357-7990  
441M

**Ronald F. Miller**  
(304) 357-7959  
229W

**Joseph M. Minard**  
(304) 357-7904  
206W

**David C. Nohe**  
(304) 357-7970  
213W

**Corey Palumbo**  
(304) 357-7880  
210W

**Robert H. Plymale**  
(304) 357-7937  
417M

**Roman Prezioso**  
(304) 357-7961  
465M

**Herb Snyder**  
(304) 357-7957  
217W

**Ron Stollings**  
(304) 357-7939  
439M

**Dave Sypolt**  
(304) 357-7914  
203W

**Gregory A. Tucker**  
(304) 357-7906  
200W

**John R. Unger II**  
(304) 357-7933  
227M

**Erik Wells**  
(304) 357-7841  
417M

**Bob Williams**  
(304) 357-7995  
209W

**Mark Wills**  
(304) 357-7843  
214W

**Jack Yost**  
(304) 357-7984  
209W



## House of Delegates - Capitol Phone Numbers & Offices

**Bill Anderson**  
(304) 340-3168  
151R

**Troy Andes**  
(304) 340-3121  
150R

**Tim Armstead**  
(304) 340-3240  
264M

**Bob Ashley**  
(304) 340-3185  
258M

**Tom Azinger**  
(304) 340-3202  
231E

**Anthony Barill**  
(304) 340-3173  
219E

**Larry W. Barker**  
(304) 340-3149  
224E

**Brent Boggs**  
(304) 340-3220  
228M

**Anna Border**  
(304) 340-3136  
230E

**Bonnie Brown**  
(304) 340-3106  
207E

**Greg Butcher**  
(304) 340-3113  
219E

**Denise L. Campbell**  
(304) 340-3145  
225E

**Thomas W. Campbell**  
(304) 340-3280  
472M

**Samuel J. Cann Sr.**  
(304) 340-3118  
209E

**Ray Canterbury**  
(304) 340-3131  
231E

**Mike Caputo**  
(304) 340-3249  
246M

**Mitch Carmichael**  
(304) 340-3115  
258M

**Daryl Cowles**  
(304) 340-3177  
6R-A

**Kevin J. Craig**  
(304) 340-3350  
215E-B

**Gerald L. Crosier**  
(304) 340-3188  
220E

**Phil Diserio**  
(304) 340-3367  
222E

**John Doyle**  
(304) 340-3184  
202E

**Walter E. Duke**  
(304) 340-3151  
151R

**John N. Ellem**  
(304) 340-3394  
150R

**Joe Ellington**  
(304) 340-3172  
150R

**Allen V. Evans**  
(304) 340-3399  
231E

**Ryan Ferns**  
(304) 340-3270  
218E

**Michael T. Ferro**  
(304) 340-3111  
222E

**Barbara Evans Fleischauer**  
(304) 340-3169  
201E

**Ron Fragale**  
(304) 340-3114  
242M

**John R. Frazier**  
(304) 340-3396  
221E

**Marty Gearheart**  
(304) 340-3179  
150R

**Roy Givens**  
(304) 340-3129  
221E

**Nancy Peoples Guthrie**  
(304) 340-3156  
206E

**Daniel J. Hall**  
(304) 340-3119  
226E

**Bill Hamilton**  
(304) 340-3167  
231E

**William G. Hartman**  
(304) 340-3178  
202E

**Barbara Hatfield**  
(304) 340-3140  
214E

**Eric L. Householder**  
(304) 340-3274  
150R

**Gary G. Howell**  
(304) 340-3191  
4R

**Mark Hunt**  
(304) 340-3392  
400M

**Richard J. Iaquina**  
(304) 340-3161  
220E

**Lynwood Ireland**  
(304) 340-3195  
151R

**Ronnie D. Jones**  
(304) 340-3120  
218E

**Larry D. Kump**  
(304) 340-3122  
6R

**Patrick Lane**  
(304) 340-3275  
150R

**Tiffany Lawrence**  
(304) 340-3152  
227E

**Linda Longstreth**  
(304) 340-3124  
215E-C

**Virginia Mahan**  
(304) 340-3102  
206E

**Tim Manchin**  
(304) 340-3166  
212E

**Mike Manypenny**  
(304) 340-3139  
203E

**Justin Marcum**  
(304) 340-3126  
229E

**Charlene Marshall**  
(304) 340-3900  
214E

**Helen Martin**  
(304) 340-3130  
216E

**Harold Michael**  
(304) 340-3340  
233E

**Tim Miley**  
(304) 340-3252  
418M

**Carol Miller**  
(304) 340-3176  
230E

**Jonathan Miller**  
(304) 340-3147  
6U-C

**Clif Moore**  
(304) 340-3189  
200E-A

**Jim Morgan**  
(304) 340-3192  
213E

**Ricky Moye**  
(304) 340-3162  
217E

**Eric Nelson**  
(304) 340-3181  
230E

**John D. O'Neal IV**  
(304) 340-3164  
150R

**John Overington**  
(304) 340-3148  
258M

**Amanda Pasdon**  
(304) 340-3153  
228E

**Brady Paxton**  
(304) 340-3337  
442M

**Don Perdue**  
(304) 340-3269  
200E-C

**David G. Perry**  
(304) 340-3117  
204E

**Dave Pethtel**  
(304) 340-3158  
229E

**Linda Goode Phillips**  
(304) 340-3163  
225E

**Rupert Phillips Jr.**  
(304) 340-3174  
224E

**John Pino**  
(304) 340-3170  
223E

**Daniel Poling**  
(304) 340-3137  
216E

**Mary M. Poling**  
(304) 340-3265  
434M

**Meshea Poore**  
(304) 340-3248  
208E

**Doug Reynolds**  
(304) 340-3199  
210E

**Ralph Rodighiero**  
(304) 340-3154  
217E

**William R. Romine**  
(304) 340-3226  
151R

**Ruth Rowan**  
(304) 340-3157  
2R

**Brian Savilla**  
(304) 340-3141  
4R

**Stan Shaver**  
(304) 340-3146  
204E

**Harold Sigler**  
(304) 340-3143  
2R

**Doug Skaff Jr.**  
(304) 340-3362  
226E

**Margaret Donaldson Smith**  
(304) 340-3123  
227E

**Rick Snuffer**  
(304) 340-3183  
150R

**Kelli Sobonya**  
(304) 340-3175  
230E

**Margaret Anne Stagers**  
(304) 340-3197  
201E

**Dale Stephens**  
(304) 340-3395  
211E

**Erikka Storch**  
(304) 340-3378  
6R-A

**Josh Stowers**  
(304) 340-3384  
212E

**Linda Sumner**  
(304) 340-3180  
228E

**Randy Swartzmiller**  
(304) 340-3138  
203E

**Joe Talbott**  
(304) 340-3116  
205E

**Rick Thompson**  
(304) 340-3210  
228M

**Scott G. Varner**  
(304) 340-3187  
209E

**David Walker**  
(304) 340-3135  
210E

**Ron Walters**  
(304) 340-3194  
151R

**Danny Wells**  
(304) 340-3287  
208E

**Harry Keith White**  
(304) 340-3230  
462M

**Larry A. Williams**  
(304) 340-3081  
223E

## Senate - Leadership

<b>Senate President:</b>	Jeffrey V. Kessler
<b>President Pro Tempore:</b>	Joseph M. Minard
<b>Majority Leader:</b>	John Unger II
<b>Majority Whip:</b>	D. Richard Browning
<b>Minority Leader:</b>	Mike Hall
<b>Minority Whip:</b>	Karen L. Facemyer

## Senate - Standing Committees

### Agriculture

Ronald Miller - *Chair*  
Bob Williams - *Vice Chair*  
Beach, Fanning, Helmick, Laird, Minard, Snyder, Facemyer, Nohe, Sypolt

### Banking & Insurance

Joseph Minard - *Chair*  
Mark Wills - *Vice Chair*  
Chafin, Fanning, Green, Helmick, McCabe, Palumbo, Prezioso, Tucker, Facemyer, Hall, Nohe

### Confirmations

Larry Edgell - *Chair*  
Truman Chafin - *Vice Chair*  
Browning, Facemire, Plymale, Miller, Snyder, Hall, Sypolt

### Economic Development

Richard Browning - *Chair*  
Orphy Klempa - *Vice Chair*  
Chafin, Facemire, Helmick, Kirkendoll, McCabe, Prezioso, Snyder, Stollings, Wells, Facemyer, Hall, Sypolt

### Education

Robert Plymale - *Chair*  
Erik Wells - *Vice Chair*  
Beach, Browning, Chafin, Edgell, Foster, Laird, Stollings, Tucker, Unger, Wills, Barnes, Boley

### Energy, Industry & Mining

Douglas Facemire - *Chair*  
Art Kirkendoll - *Vice Chair*  
Beach, Helmick, Jenkins, Klempa, Minard, Stollings, Snyder, Yost, Facemyer, Nohe, Sypolt

### Enrolled Bills

Gregory Tucker - *Chair*  
Evan Jenkins - *Vice Chair*  
McCabe, Wells, Barnes

### Finance

Roman Prezioso - *Chair*  
Douglas Facemire - *Vice Chair*  
Chafin, Edgell, Green, Helmick, Laird, McCabe, Miller, Plymale, Stollings, Unger, Wells, Yost, Boley, Hall, Sypolt



## Senate - Standing Committees (con't)

### **Government Organization**

Herb Snyder - *Chair*

Ronald Miller - *Vice Chair*

Browning, Foster, Green, Jenkins, Kirkendoll, Klempa, McCabe, Minard, Williams, Yost, Boley, Sypolt

### **Health & Human Resources**

Ron Stollings - *Chair*

William Laird - *Vice Chair*

Foster, Kirkendoll, Miller, Palumbo, Plymale, Prezioso, Tucker, Wills, Yost, Boley, Hall

### **Interstate Cooperation**

Orphy Klempa - *Chair*

Gregory Tucker - *Vice Chair*

Chafin, Palumbo, Wells, Nohe, Sypolt, Kessler (ex-officio, non-voting)

### **Judiciary**

Corey Palumbo - *Chair*

Mark Wills - *Vice Chair*

Beach, Browning, Fanning, Foster, Jenkins, Kirkendoll, Klempa, Minard, Snyder, Tucker, Unger, Williams, Barnes, Facemyer, Nohe

### **Labor**

Jack Yost - *Chair*

Ronald Miller - *Vice Chair*

Edgell, Fanning, Foster, Green, Klempa, Williams, Wills, Barnes, Nohe

### **Military**

Erik Wells - *Chair*

Jack Yost - *Vice Chair*

Edgell, Green, Jenkins, Laird, Williams, Barnes, Boley

### **Natural Resources**

William Laird - *Chair*

John Fanning - *Vice Chair*

Beach, Edgell, Facemire, Green, Helmick, Prezioso, Williams, Wills, Barnes, Boley, Facemyer

### **Pensions**

Dan Foster - *Chair*

Larry Edgell - *Vice Chair*

Jenkins, McCabe, Plymale, Hall, Nohe

### **Rules**

Jeffrey Kessler - *Chair*

Browning, Minard, Palumbo, Plymale, Prezioso, Snyder, Stollings, Unger, Boley, Hall

### **Transportation & Infrastructure**

Robert Beach - *Chair*

Orphy Klempa - *Vice Chair*

Facemire, Fanning, Kirkendoll, Plymale, Tucker, Barnes, Facemyer

## House of Delegates - Leadership

<b>Speaker of the House:</b>	Rick Thompson
<b>Speaker Pro Tempore:</b>	Ron Fragale
<b>Majority Leader:</b>	Brent Boggs
<b>Majority Whip:</b>	Mike Caputo
<b>Assistant Majority Whips:</b>	Larry Barker                      Dan Poling
	Michael Ferro                      Peggy Donaldson Smith
	Richard Iaquinta                  Margaret Anne Stagers
	Clif Moore                          Josh Stowers
	Dave Pethtel                        Randy Swartzmiller
<b>Minority Leader:</b>	Tim Armstead
<b>Minority Whip:</b>	Mitch Carmichael
<b>Assistant Minority Whips:</b>	Troy Andes
	Ray Canterbury
	Daryl Cowles
	Lynwood "Woody" Ireland
	Carol Miller
<b>House Chaplain:</b>	Charlene Marshall

## House of Delegates - Standing Committees

### **Agriculture**

Greg Butcher - *Chair*

David Walker - *Vice Chair*

Allen Evans - *Minority Chair*

Ray Canterbury - *Minority Vice Chair*

Boggs, Guthrie, Hall, Manypenny, Martin, Morgan, L. Phillips, R. Phillips, M. Poling, Reynolds, Rodighiero, Swartzmiller, Wells, Williams, Anderson, Border, Ireland, C. Miller, Overington, Romine, Storch

### **Banking & Insurance**

Clif Moore - *Chair (Banking)*

Dave Perry - *Chair (Insurance)*

Doug Reynolds - *Vice Chair (Banking)*

Daniel Hall - *Vice Chair (Insurance)*

Tom Azinger - *Minority Chair (Banking)*

Bob Ashley - *Minority Chair (Insurance)*

Jonathan Miller - *Minority Vice Chair (Banking)*

Ron Walters - *Minority Vice Chair (Insurance)*

Cann, Ferns, Fragale, Frazier, Hartman, Hunt, Iaquinta, Mahan, Manchin, Michael, Morgan, Shaver, Walker, Carmichael, Nelson, O'Neal, Savilla



## House of Delegates - Standing Committees (con't)

### **Constitutional Revision**

Barbara Fleischauer - *Chair*

Nancy Guthrie - *Vice Chair*

John Overington - *Minority Chair*

William Romine - *Minority Vice Chair*

Brown, Caputo, Doyle, Ferro, Fragale, Frazier, Hatfield, Hunt, Marshall, Moore, Morgan, Perdue, Poore, Varner, Wells, Armstead, Ellem, Householder, Kump, Lane, Sobonya

### **Education**

Mary Poling - *Chair*

Brady Paxton - *Vice Chair*

Walter Duke - *Minority Chair*

Linda Sumner - *Minority Vice Chair*

Barill, D. Campbell, Caputo, Craig, Crosier, Fragale, Lawrence, Marcum, Moye, Perry, Pethtel, Rodighiero, Shaver, Smith, Armstead, Ellington, Gearheart, Pasdon, Rowan, Savilla, Sigler

### **Energy, Industry & Labor/Economic Development & Small Business**

Larry Barker - *Chair (Energy, Industry & Labor)*

Doug Skaff - *Chair (Economic Development & Small Business)*

Stan Shaver - *Vice Chair (Energy, Industry & Labor)*

John Pino - *Vice Chair (Economic Development & Small Business)*

Kelli Sobonya - *Minority Chair (Energy, Industry & Labor)*

Troy Andes - *Minority Chair (Economic Development & Small Business)*

Carol Miller - *Minority Vice Chair (Energy, Industry & Labor)*

Mitch Carmichael - *Minority Vice Chair (Economic Development & Small Business)*

Barill, Butcher, Caputo, Diserio, Fleischauer, Mahan, Manypenny, Marcum, Marshall, Martin, Moye, Paxton, D. Poling, Walker, Savilla, Sigler, Snuffer, Storch

### **Enrolled Bills**

Meshea Poore - *Chair*

Micheal Ferro - *Vice Chair*

Fragale, Overington

### **Finance**

Harry Keith White - *Chair*

Tom Campbell - *Vice Chair*

William Anderson - *Minority Chair*

Mitch Carmichael - *Minority Vice Chair*

Cann, Guthrie, Iaquina, Mahan, Marshall, Perdue, L. Phillips, D. Poling, M. Poling, Reynolds, Skaff, Stowers, Varner, Williams, Ashley, Andes, Canterbury, Cowles, Evans, C. Miller, Walters

### **Government Organization**

Jim Morgan - *Chair*

Dale Stephens - *Vice Chair*

William Romine - *Minority Chair*

Tom Azinger - *Minority Vice Chair*

Boggs, Butcher, Diserio, Ferns, Givens, Hall, Hartman, Hatfield, Jones, Martin, R. Phillips, Staggers, Swartzmiller, Talbott, Border, Householder, Howell, Kump, Nelson, Snuffer, Storch

## House of Delegates - Standing Committees (con't)

### Health & Human Resources

Don Perdue - *Chair*

Barbara Hatfield - *Vice Chair*

Joe Ellington - *Minority Chair*

Jonathan Miller - *Minority Vice Chair*

Barill, D. Campbell, T. Campbell, Ferns, Fleischauer, Lawrence, Marshall, Moore, Moye, Perry, L. Phillips, Poore, Rodighiero, Staggers, Andes, Border, Householder, Lane, C. Miller, Pasdon, Rowan

### Interstate Cooperation

John Doyle - *Chair*

Ralph Rodighiero - *Vice Chair*

Ferro, Frazier, Reynolds, Storch, Walters

### Judiciary

Tim Miley - *Chair*

Mark Hunt - *Vice Chair*

John Ellem - *Minority Chair*

Patrick Lane - *Minority Vice Chair*

Barker, Brown, Doyle, Ferro, Fleischauer, Frazier, Longstreth, Manchin, Manypenny, Michael, Moore, Pino, Poore, Walker, Wells, Hamilton, Ireland, J. Miller, O'Neal, Overington, Sobonya

### Natural Resources

Joe Talbott - *Chair*

Gerald Crosier - *Vice Chair*

Bill Hamilton - *Minority Chair*

Woody Ireland - *Minority Vice Chair*

Fragale, Guthrie, Hall, Manypenny, Martin, L. Phillips, R. Phillips, Pino, Reynolds, Rodighiero, Shaver, Swartzmiller, Varner, Wells, Anderson, Canterbury, Duke, Ellem, Evans, Romine, Sigler

### Pensions & Retirement

Dave Pethtel - *Chair*

Stowers - *Vice Chair*

Givens, Guthrie, D. Poling, Canterbury, Duke

### Political Subdivisions

Tim Manchin - *Chair*

Tiffany Lawrence - *Vice Chair*

Linda Sumner - *Minority Chair*

Daryl Cowles - *Minority Vice Chair*

Cann, Doyle, Frazier, Hartman, Jones, Longstreth, Marcum, Morgan, R. Phillips, Poore, Smith, Stephens, Varner, Williams, Duke, Ellington, Gearheart, Householder, Kump, O'Neal, Overington



## House of Delegates - Standing Committees (con't)

### **Roads & Transportation**

Margaret Staggers - *Chair*

Linda Goode Phillips - *Vice Chair*

Daryl Cowles - *Minority Chair*

Allen Evans - *Minority Vice Chair*

Barker, Boggs, Butcher, T. Campbell, Crosier, Hall, Michael, D. Poling, Skaff, Smith, Stephens, Stowers, Walker, Wells, Ellington, Gearheart, Howell, Nelson, Pasdon, Savilla, Snuffer

### **Rule-Making Review**

Bonnie Brown - *Chair*

Dan Poling - *Vice-Chair*

Fleischauer, Talbott, Overington, Sobonya, Thompson (Ex Officio, Nonvoting)

### **Rules**

Speaker Rick Thompson - *Chair*

Boggs, Caputo, Fragale, Hatfield, Marshall, Miley, Morgan, Paxton, M. Poling, Talbott, Varner, White, Anderson, Armstead, Ashley, Carmichael, Duke, Overington, Sumner

### **Senior Citizen Issues**

Larry Williams - *Chair*

Ricky Moye - *Vice Chair*

Ruth Rowan - *Minority Chair*

Walter Duke - *Minority Vice Chair*

Butcher, D. Campbell, Craig, Ferro, Hatfield, Longstreth, Manchin, Manypenny, Marshall, Moore, Pethtel, Pino, D. Poling, Stephens, Gearheart, Hamilton, Howell, Kump, Sigler, Snuffer, Sumner

### **Veterans Affairs & Homeland Security**

Richard Iaquina - *Chair (Veterans Affairs)*

Randy Swartzmiller - *Chair (Homeland Security)*

Linda Longstreth - *Vice Chair (Veterans Affairs)*

Margaret Smith - *Vice Chair (Homeland Security)*

Tom Azinger - *Minority Chair (Veterans Affairs)*

Ron Walters - *Minority Chair (Homeland Security)*

Ruth Rowan - *Minority Vice Chair (Veterans Affairs)*

Bob Ashley - *Minority Vice Chair (Homeland Security)*

Barrill, Cann, Craig, Ferro, Fleischauer, Givens, Hatfield, Jones, Paxton, Pethtel, Staggers, Stephens, Armstead, Howell, Nelson, O'Neal, Pasdon

# Senate Chamber Seating Chart

## West Virginia Senate 80th Legislature 2012

Press



Doorkeeper



Sergeant at Arms

Press

Kessler  
2nd  
Marshall  
25

Laird  
11th  
Fayette  
26

Kirkendoll  
7th  
Logan  
27

Beach  
13th  
Monongalia  
28

Wells  
8th (Sr.)  
Kanawha  
29

Minard  
12th  
Harrison  
30

McCabe  
17th (Sr.)  
Kanawha  
31

Fanning  
6th  
McDowell  
33

Foster  
17th (Jr.)  
Kanawha  
32

Helmick  
15th  
Pocahontas  
34

Jenkins  
5th  
Cabell  
17

Williams  
14th  
Taylor  
18

Klempa  
1st  
Ohio  
19

Yost  
1st  
Brooke  
20

Miller  
10th  
Greenbrier  
21

Tucker  
11th  
Nicholas  
22

Wills  
10th  
Mercer  
23

Edgell  
2nd  
Weitzel  
24

Snyder  
16th  
Jefferson  
16

Chafin  
6th  
Mingo  
9

Green  
9th  
Raleigh  
10

Sypolt  
14th  
Preston  
11

Barnes  
15th  
Randolph  
12

Browning  
9th  
Wyoming  
13

Stollings  
7th  
Boone  
14

Facemire  
12th  
Braxton  
15

Snyder  
16th  
Jefferson  
16

Palumbo  
8th (Jr.)  
Kanawha  
8

Boley  
3rd  
Pleasants  
1

Nohe  
3rd  
Wood  
2

Facemyer  
4th  
Jackson  
3

Hall  
4th  
Putnam  
4

Unger  
16th  
Berkeley  
5

Prezioso  
13th  
Marion  
6

Plymate  
5th  
Wayne  
7

Senate Clerk/Parliamentarian  
Darrell Holmes & Staff

Senate President  
Jeffrey V. Kessler

Pages

Pages

# House Chamber Seating Chart

Doorkeeper  
John Roberts

Sergeant-at-Arms  
Oce Smith

Hatfield 30th 45  
T. Campbell 28th 39  
D. Poling 10th 33  
Morgan 15th 32  
M. Poling 40th 25

Guthrie 30th 46  
Reynolds 16th 40  
Craig 15th 34  
L. Phillips 22nd 27  
Staggers 29th 20  
White 21st 14

Wells 30th 47  
D. Campbell 37th 41  
Rodighiero 19th 35  
Hall 22nd 28  
Perry 29th 21  
Marcum 20th 15

Skaff 30th 48  
Hartman 37th 42  
R. Phillips 19th 36  
Pino 29th 29  
Frazier 25th 22  
Moore 23rd 16

Poore 31st 49  
Doyle 57th 43  
Stowers 19th 37  
Lawrence 58th 30  
Barill 44th 23  
Talbot 36th 17

Brown 30th 50  
Fleischauer 44th 44  
Butcher 19th 38  
Marshall 44th 31  
Hunt 30th 24  
Perdue 17th 18

Paxton 13th 95  
Mahan 27th 89  
Stephens 16th 82  
Manchin 43rd 75  
Iaquinta 41st 69  
Martin 13th 64

Walker 33rd 97  
Covles 51st 91  
Howell 49th 84  
Ireland 7th 77  
Savilla 14th 71  
Williams 45th 66

Smith 38th 96  
Shaver 46th 90  
J. Miller 53rd 83  
Longstreth 43rd 76  
Hamilton 39th 70  
Barker 18th 65

Cann 41st 98  
Householder 56th 92  
Kump 52nd 85  
Snuffer 27th 78  
C. Miller 15th 72  
Border 9th 67

Michael 47th 99  
Azinger 10th 93  
Rowan 50th 86  
O'Neal 27th 79  
Summer 27th 73  
Anderson 8th 68

Crosier 26th 100  
Evans 48th 94  
Pasdon 44th 87  
Sobonya 16th 80  
Ellem 10th 74

Romine 6th 88  
Duke 54th 81

Richard Thompson 17th 13

Ferns 3rd 12

Varner 4th 11

Ferro 4th 10

Peihel 5th 9

Swartzmiller 1st 8

Manyenny 42nd 7

Boggs 34th 6

Fragale 41st 5

Caputo 43rd 4

Givens 2nd 3

Jones 1st 2

Ennis 2nd 1

Ashley 11th 57

Storch 3rd 58

Walters 32nd 59

Lane 32nd 60

Nelson 30th 61

Canterbury 28th 62

Sigler 35th 63

Armstead 32nd 51

Carmichael 12th 52

Andes 14th 53

Overington 55th 54

Ellington 25th 55

Geartheart 24th 56

## West Virginia House of Delegates 80th Legislature 2012

Press

Press

House Clerk/Parliamentarian  
Greg Gray & Staff

House Speaker  
Richard Thompson

Pages

Pages

# House of Delegates District Map

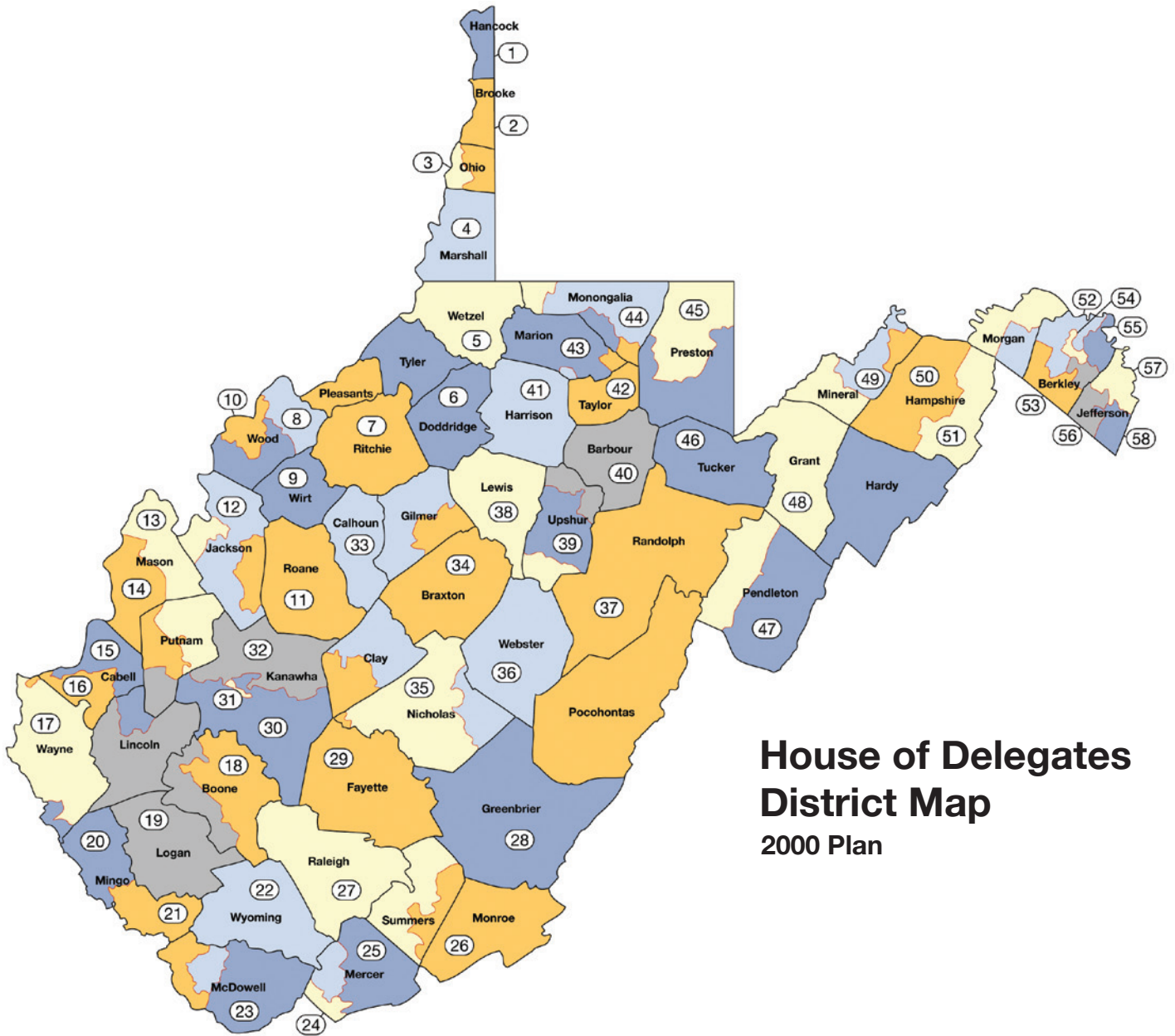

**House of Delegates  
District Map  
2000 Plan**

➡ For interactive State Senate and House district maps, and a district search by zipcode, go to the legislature's website at [www.legis.state.wv.us](http://www.legis.state.wv.us) and click on the "District Maps" link.



## House of Delegates by District

**District 1**

Ronnie Jones  
Randy Swartzmiller

**District 2**

Phil Diserio  
Roy Givens

**District 3**

Ryan Ferns  
Erikka Storch

**District 4**

Michael T. Ferro  
Scott G. Varner

**District 5**

Dave Pethtel

**District 6**

Roger Romine

**District 7**

Lynwood "Woody" Ireland

**District 8**

E. W. Bill Anderson

**District 9**

Anna Border

**District 10**

Tom Azinger  
John Ellem  
Daniel Poling

**District 11**

Bob Ashley

**District 12**

Mitch Carmichael

**District 13**

Helen Martin  
Brady Paxton

**District 14**

Troy Andes  
Brian Savilla

**District 15**

Kevin J. Craig  
Carol Miller  
James H. Morgan

**District 16**

Doug Reynolds  
Kelli Sobonya  
Dale Stephens

**District 17**

Don Perdue  
Richard Thompson

**District 18**

Larry Barker

**District 19**

Greg Butcher  
Rupert Phillips  
Ralph Rodighiero  
Josh Stowers

**District 20**

Justin Marcum

**District 21**

Harry Keith White

**District 22**

Daniel J. Hall  
Linda Goode Phillips

**District 23**

Clif Moore

**District 24**

Marty Gearheart

**District 25**

Joe Ellington  
John R. Frazier

**District 26**

Gerald Crosier

**District 27**

Virginia Mahan  
Ricky Moye  
John D. O'Neal  
Rick Snuffer  
Linda Sumner

**District 28**

Thomas W. Campbell  
Ray Canterbury

**District 29**

David G. Perry  
John Pino  
Margaret Anne Staggers

**District 30**

Bonnie Brown  
Nancy Peoples Guthrie  
Barbara Hatfield  
Mark Hunt  
Eric Nelson  
Doug Skaff Jr.  
Danny Wells

**District 31**

Meshea L. Poore

**District 32**

Tim Armstead  
Patrick Lane  
Ron Walters

**District 33**

David Walker

**District 34**

Brent Boggs

**District 35**

Harold Sigler

**District 36**

Joe Talbott

**District 37**

Denise Campbell  
Mike Ross

**District 38**

Margaret Donaldson Smith

**District 39**

Bill Hamilton

**District 40**

Mary M. Poling

**District 41**

Samuel J. Cann  
Ron Fragale  
Richard J. Iaquinta  
Tim Miley

**District 42**

Mike Manypenny

**District 43**

Mike Caputo  
Linda Longstreth  
Tim Manchin

**District 44**

Anthony Barill  
Barbara Evans Fleischauer  
Charlene Marshall  
Amanda Pasdon

**District 45**

Larry A. Williams

**District 46**

Stan Shaver

**District 47**

Harold Michael

**District 48**

Allen Evans

**District 49**

Gary Howell

**District 50**

Ruth Rowan

**District 51**

Daryl E. Cowles

**District 52**

Larry Kump

**District 53**

Jonathan Miller

**District 54**

Walter E. Duke

**District 55**

John Overington

**District 56**

Eric Householder

**District 57**

John Doyle

**District 58**

Tiffany E. Lawrence

# Senators by District & Senate District Map

**District 1**

Orphy Klempa, Ohio  
Jack Yost, Brooke

**District 2**

Larry J. Edgell, Wetzel  
Jeffrey V. Kessler, Marshall

**District 3**

Donna J. Boley, Pleasants  
David Nohe, Wood

**District 4**

Karen L. Facemyer, Jackson  
Mike Hall, Putnam

**District 5**

Evan H. Jenkins, Cabell  
Robert H. Plymale, Wayne

**District 6**

H. Truman Chafin, Mingo  
John Pat Fanning, McDowell

**District 7**

Art Kirkendoll, Logan  
Ron Stollings, Boone

**District 8**

Corey Palumbo, Kanawha  
Erik Wells, Kanawha

**District 9**

Richard Browning, Wyoming  
Mike Green, Raleigh

**District 10**

Ronald Miller, Greenbrier  
Mark Wills, Mercer

**District 11**

William R. Laird IV, Fayette  
Gregory Tucker, Nicholas

**District 12**

Douglas E. Facemire, Braxton  
Joseph M. Minard, Harrison

**District 13**

Robert Beach, Monongalia  
Roman W. Prezioso, Marion

**District 14**

Dave Sypolt, Preston  
Bob Williams, Taylor

**District 15**

Walt Helmick, Pocahontas  
Clark Barnes, Randolph

**District 16**

Herb Snyder, Jefferson  
John R. Unger II, Berkeley

**District 17**

Brooks McCabe, Kanawha  
Dan Foster, Kanawha

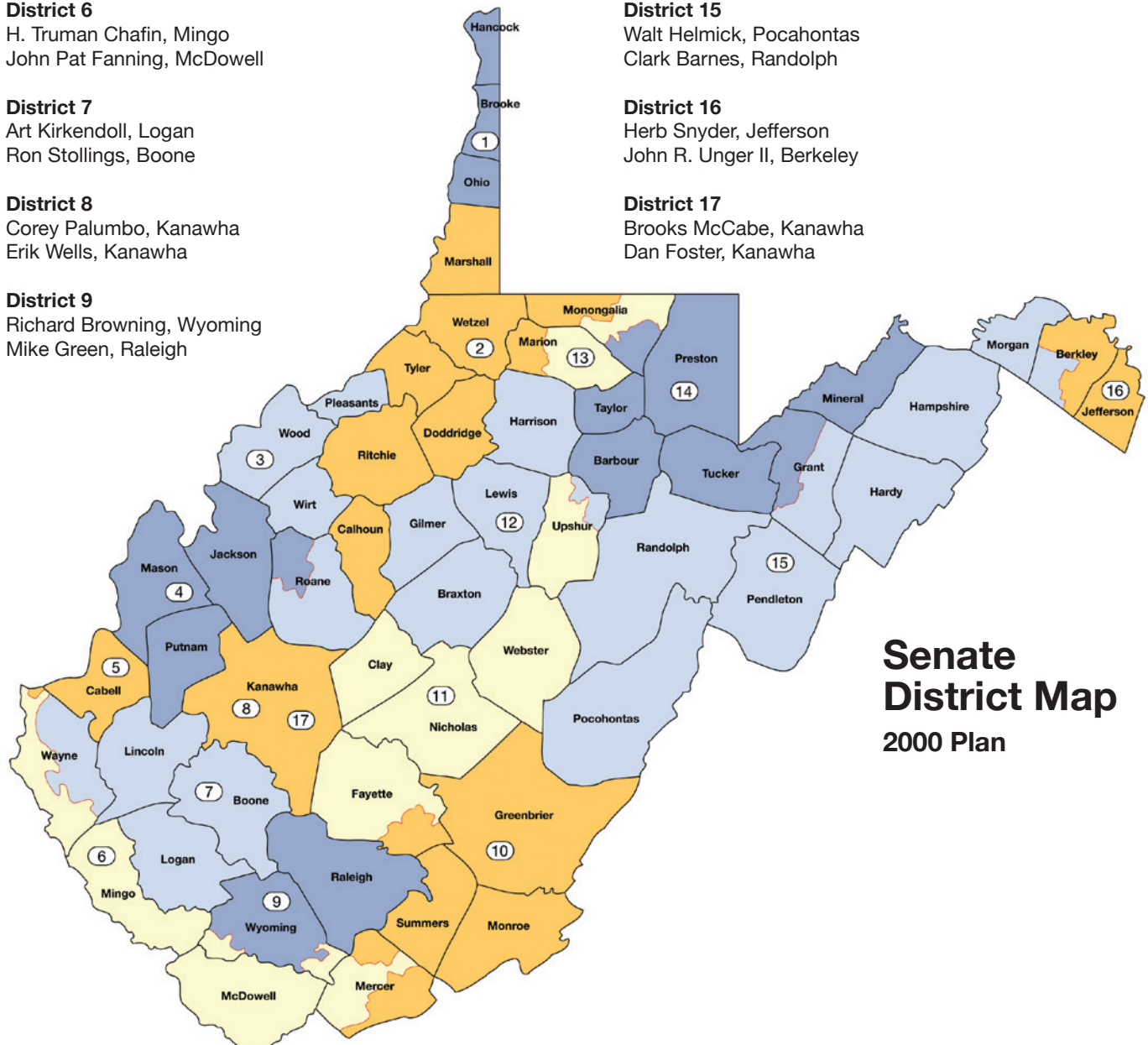

**Senate District Map**  
2000 Plan

# West Virginia State Capitol Maps

## Main Building - Basement

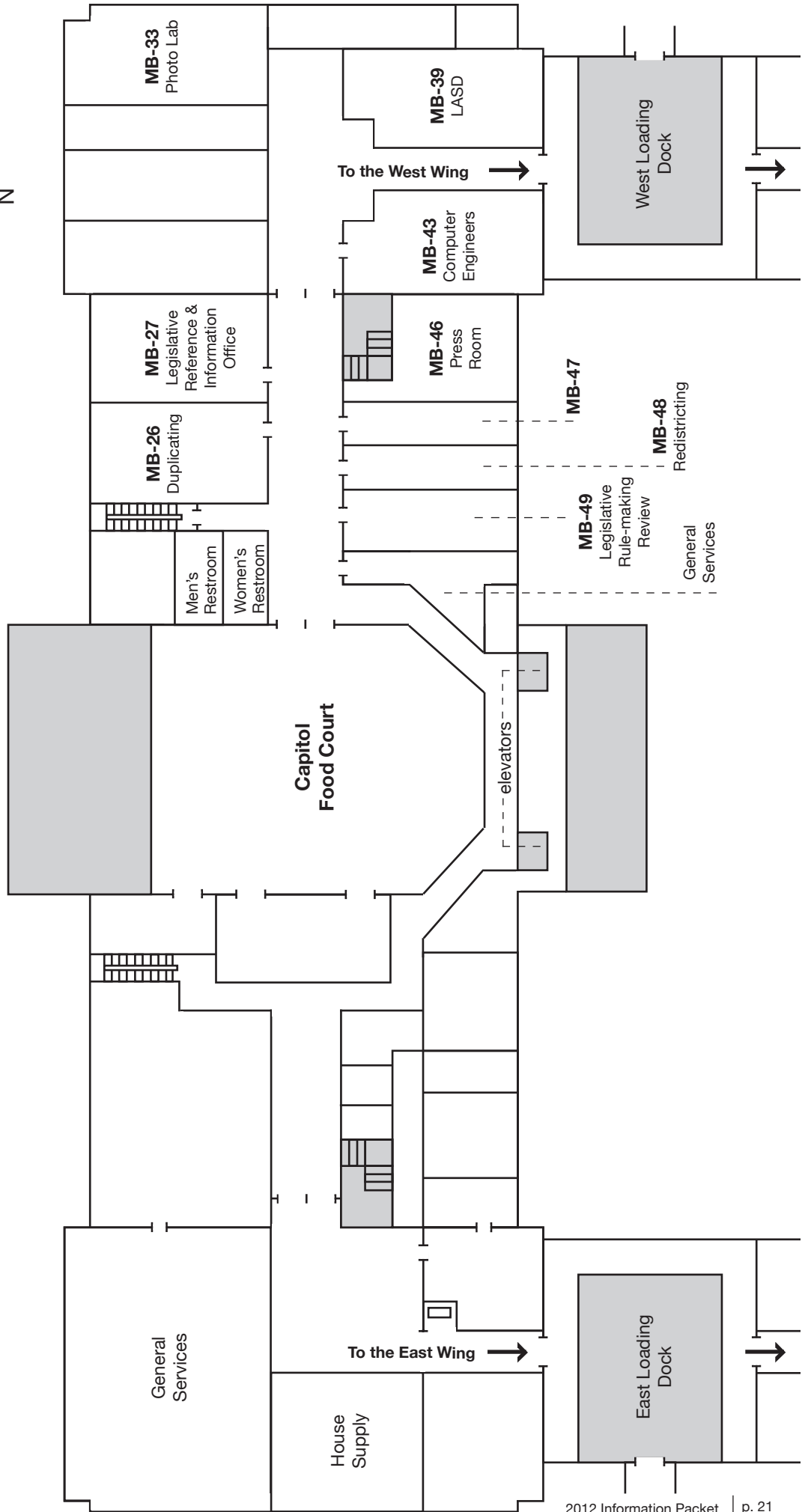
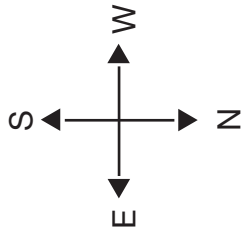

# West Virginia State Capitol Maps

## Main Building - Ground Floor

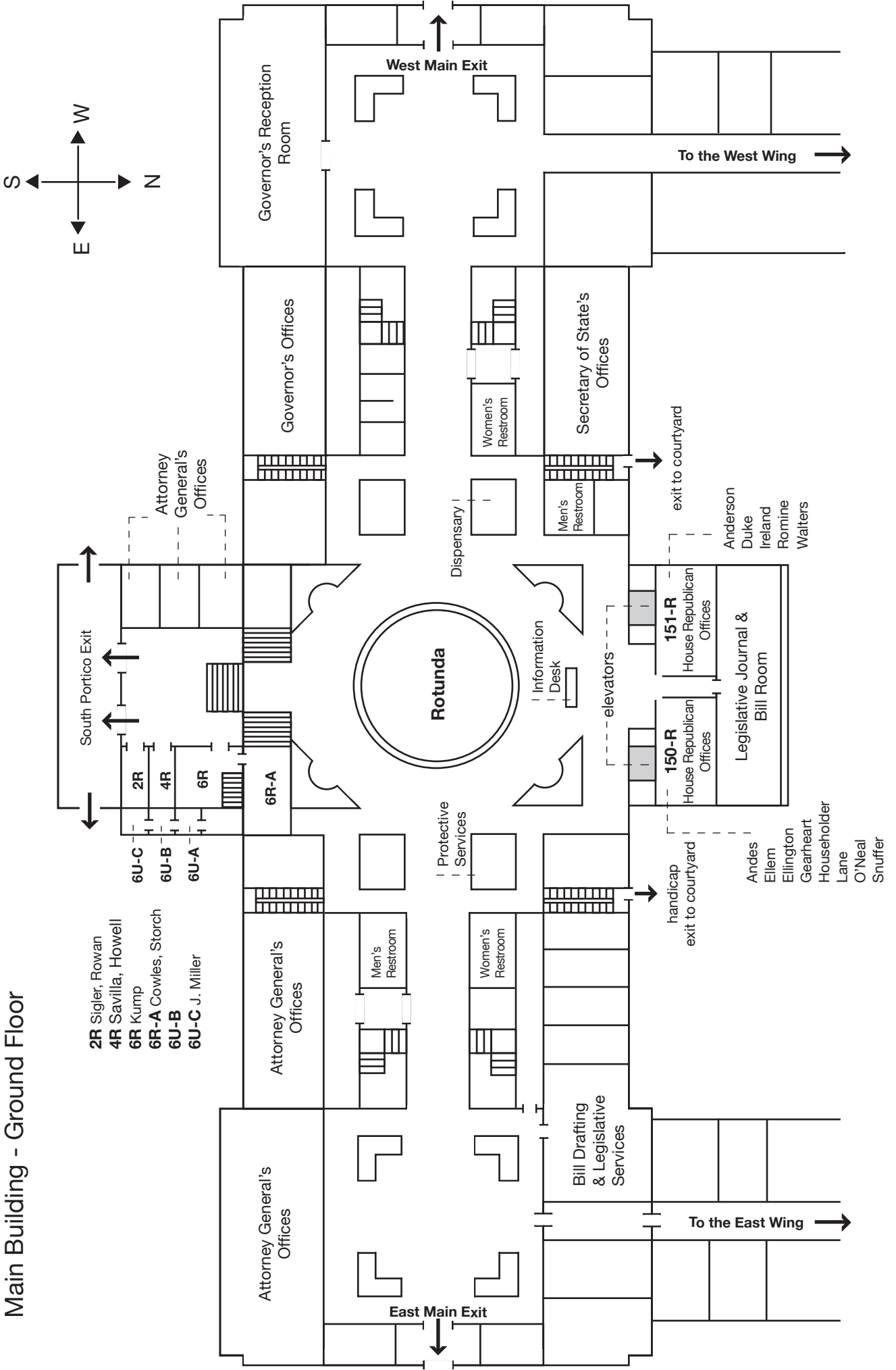



# West Virginia State Capitol Maps

## Main Building - Second Floor

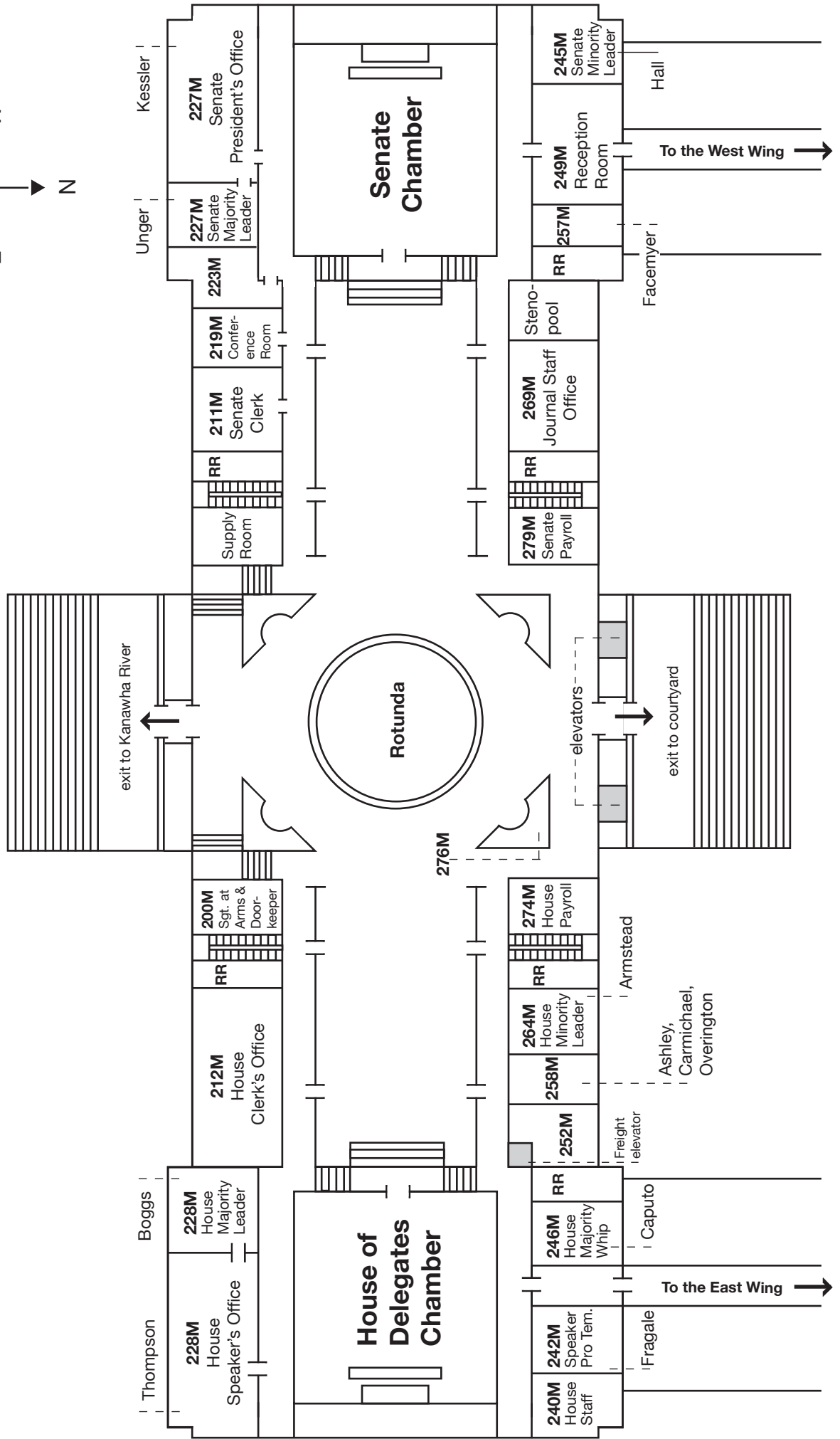
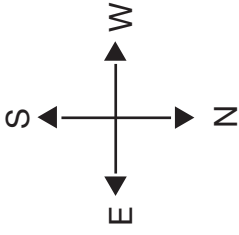



# West Virginia State Capitol Maps

## West Wing - Second Floor - Senate

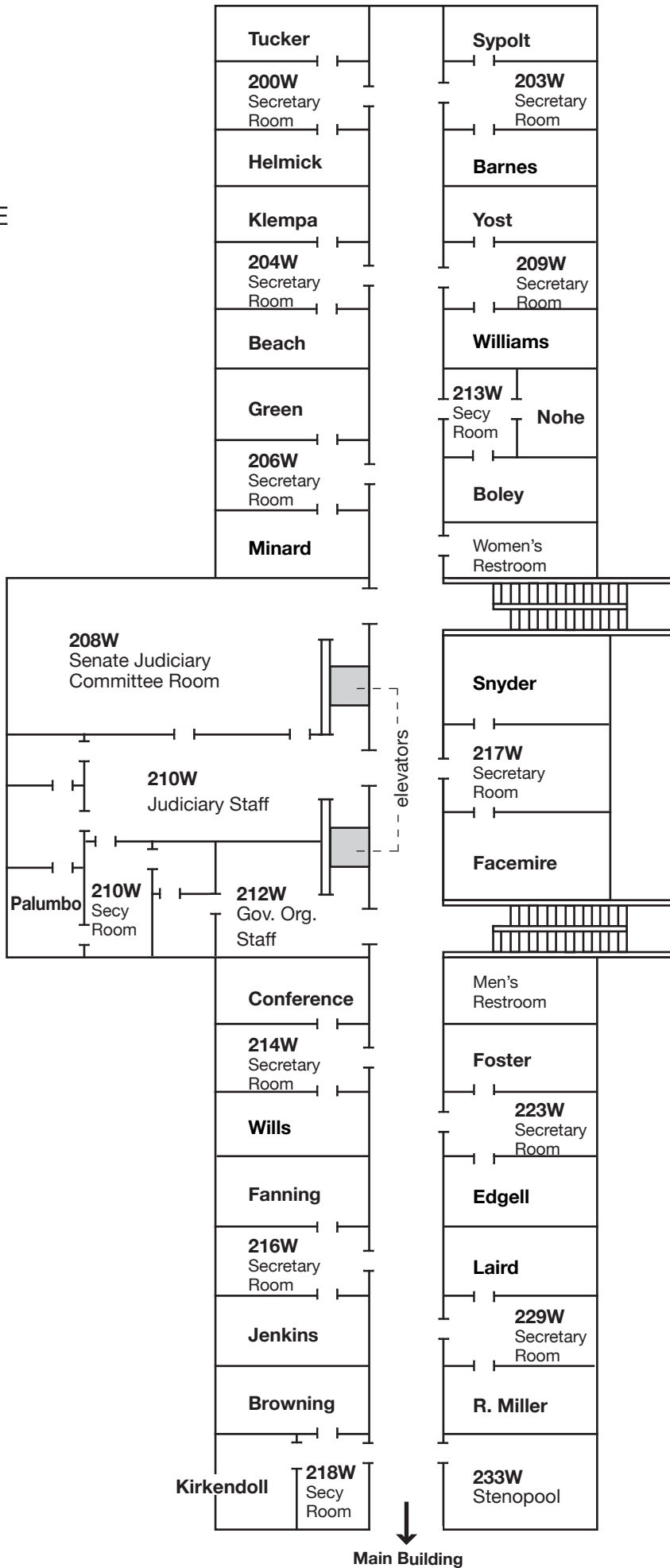
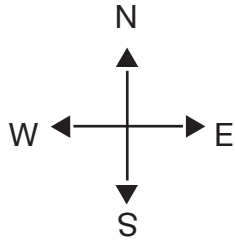

# West Virginia State Capitol Maps

## East Wing - Second Floor - House of Delegates

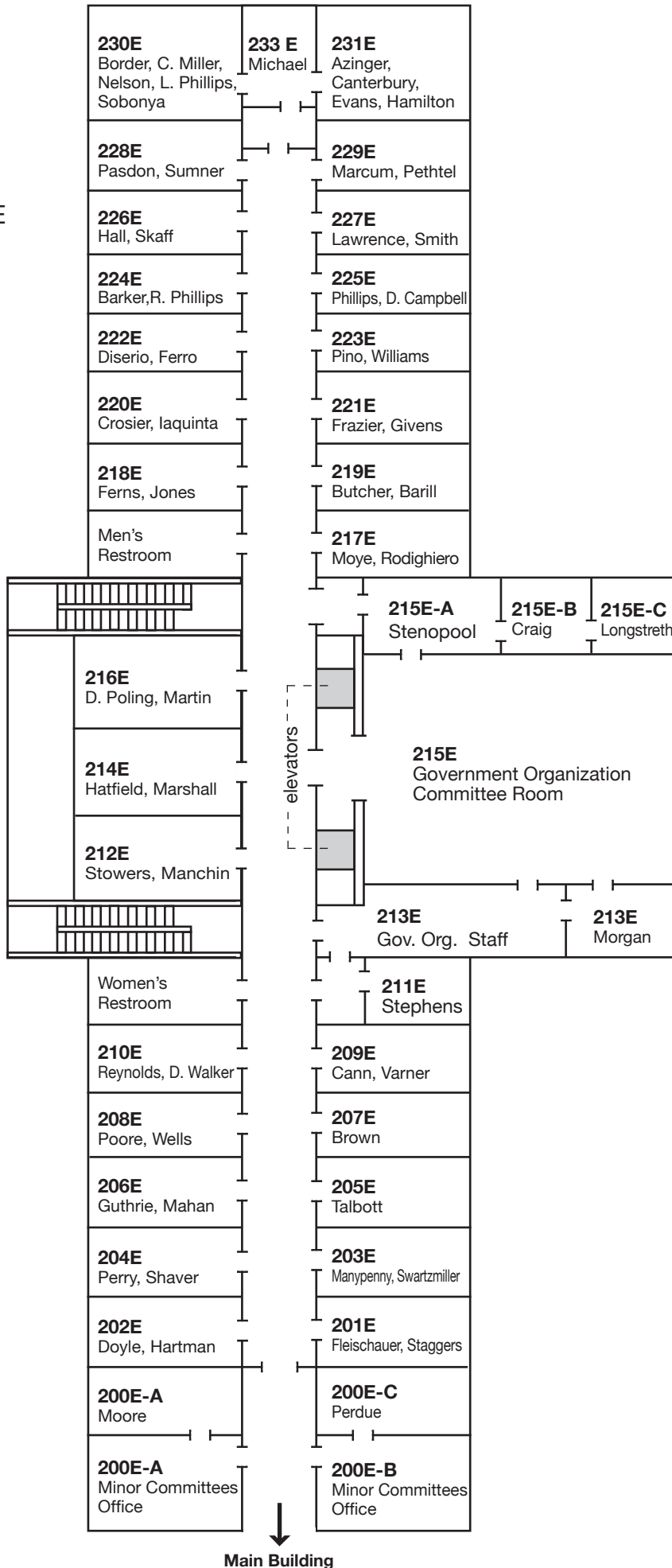
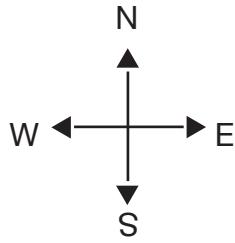

Main Building



## Toll-Free Numbers - State Agencies

<u>Air Quality Board</u>	1-866-568-6699	<u>Health Care Authority</u>	1-888-558-7002
<u>Attorney General's Office</u>		<u>Housing Development Fund</u>	1-800-933-1272
Consumer Protection /Antitrust Division	1-800-368-8808	<u>Human Rights Commission</u>	1-888-676-5546
<u>Auditor's Office</u>	1-877-982-9148	<u>Military Affairs &amp; Public Safety</u>	
Fraud Line	1-888-368-9507	Arson Hotline	1-800-233-3473
Securities Division	1-888-368-9507	Division of Corrections	1-800-525-5381
<u>Board of Exam Speech Pathology Audiology</u>	1-877-462-5460	Fire Commission	
<u>Board of Licensed Dietitians</u>	1-800-293-9832	Safe Schools Hotline	1-866-723-3982
<u>Board of Radiologic Technologists</u>	1-877-609-9869	Veterans Affairs	1-888-838-2332
<u>Board of Risk and Insurance Management</u>	1-800-345-4669	<u>Office of Health Facility Licensure &amp; Certification</u>	1-800-442-2888
<u>Bureau of Child Support Enforcement</u>	1-800-249-3778	<u>Office of Maternal and Child Health</u>	1-800-642-8522
<u>Bureau of Senior Services</u>	1-877-987-3646	or call	1-800-642-9704
<u>Center for Professional Development</u>	1-800-982-7348	Division of Child's Specialty Care Director	1-800-642-8522
<u>Commission for the Deaf &amp; Hard-of-Hearing</u>	1-877-461-3578	Division of Women's Services Director	1-800-642-8522
<u>Department of Administration</u>		<u>Public Employees Insurance Agency</u>	1-888-680-7342
Children's Health Insurance Agency	1-877-982-2447	Acordia	1-888-440-7342
Consolidated Public Retirement Board	1-800-654-4406	Express Scripts	1-877-256-4680
Ethics Commission	1-866-558-0664	Fringe Benefits Management Company	1-800-342-8017
<u>Department of Education</u>		Intracorp	1-888-853-2954
GED	1-800-642-2670	<u>Public Service Commission</u>	1-800-344-5113
Special Education	1-800-642-8541	Utility Complaints	1-800-642-8544
Teacher Certification	1-800-982-2378	<u>Purchasing Division</u>	
<u>Department of Education &amp; the Arts</u>		Surplus Property Unit	1-800-576-7587
Educational Broadcasting Authority	1-888-596-9729	<u>Rehabilitation Services</u>	1-800-642-8207
Library Commission	1-800-642-9021	<u>Secretary of State</u>	1-866-767-8683
<u>Department of Environmental Protection</u>	1-866-568-6649	<u>Solid Waste Management Board</u>	1-866-568-6649
Abandoned Mine Lands	1-800-634-5227	<u>State Bar</u>	1-888-989-8227
Dam Emergency	1-800-642-3074	<u>State Tax Department</u>	1-800-982-8297
Environmental Advocate	1-800-654-5227	<u>Tax and Revenue</u>	
Environmental Emergency	1-800-642-3074	Alcohol Beverage Control Administration	1-800-642-8208
General Assistance Program-OWM	1-800-307-8710	Division of Banking	1-800-642-9056
Pollution Prevention & Open Dump	1-800-322-5530	Insurance Commission	1-888-879-9842
Pollution Spills, Response	1-800-642-3074	Lottery Commission	1-800-982-2274
<u>Division of Labor</u>	1-877-558-5143	Tax Payers Services	1-800-982-8297
<u>Division of Surveillance &amp; Disease Control</u>	1-800-423-1271	<u>Transportation</u>	1-800-642-9292
Cancer Registry	1-800-423-1271	Division of Motor Vehicles	1-800-642-9066
<u>Division of Tourism</u>	1-800-225-5982	<u>Treasurer's Office</u>	1-800-422-7498
<u>Education &amp; State Employees Grievance Board</u>	1-866-747-6743	Unclaimed Property	1-800-642-8687
<u>Environmental Quality Board</u>	1-800-654-5227	<u>West Virginia Network-Educational Telecomputing</u>	1-800-253-1558
<u>Geological and Economic Survey</u>	1-800-984-3656	<u>WorkForce West Virginia</u>	1-800-252-5627
<u>Governor's Office</u>	1-888-438-2731	<u>WV Department of Health and Human Resources</u>	
<u>Health &amp; Human Resources</u>		AIDS/STD Hotline	1-800-642-8244
Client Services	1-800-642-8589	Alcoholics Anonymous	1-800-333-5051

## Toll-Free Numbers - con't

Black Lung Programs	1-877-422-7398
Breast & Cervical Cancer Screening Program	1-800-642-8522
Child and Adult Abuse Hotline	1-800-352-6513
Children With Special Health Care Needs Hotline	1-800-642-9704
Children's Dental Health Services Hotline	1-800-642-8522
Client Services Hotline	1-800-642-8589
Division of Recruitment Hotline	1-888-442-3456
Domestic Violence Hotline	1-800-352-6513
Early & Periodic Screening, Diagnosis, & Treatment	1-800-642-9704
Early Intervention/Part H Hotline	1-800-642-9704
Environmental Health Hotline	1-800-368-4358
Epidemiology Surveillance Hotline	1-800-423-1271
Family Matters Hotline	1-800-558-2357
Health Care Authority Hotline	1-888-558-7002
Home Health Agency Hotline	1-800-442-2888
Immunization Program Hotline	1-800-642-3634
Pediatric Health Services Hotline	1-800-642-9704
Poison Center Hotline	1-800-222-1222
Radiation, Toxins, and Indoor Air Quality Hotline	1-800-922-1255
Right From the Start	1-800-642-8522
WIC (Womens, Infants, Children) Hotline	1-800-642-8522
WV Chip Hotline	1-877-982-2447

## State Colleges & Universities

### State Public Colleges & Universities:

Bluefield State College	1-800-344-8892
Concord University	1-800-344-6679
Eastern WV Community & Technical College	1-877-982-2322
Fairmont State Community & Technical College	1-800-641-5678
Fairmont State University	1-800-641-5678
Glenville State College	1-800-924-2010
Marshall Community & Technical College	1-800-642-3437
Marshall University	1-877-GO HERD1
New River Community & Technical College	1-866-349-3739
Potomac State College	1-800-262-7332
Shepherd University	1-800-344-5231
Southern WV Community & Technical College	1-866-798-2821
The Community and Technical College of Shepherd	1-800-344-5231
West Liberty State College	1-866-WESTLIB
West Virginia Northern Community College	1-866-WESTLIB
West Virginia School of Osteopathic Medicine	1-800-356-7836
West Virginia State Community & Technical College	1-800-987-2112
West Virginia State University	1-800-987-2112
West Virginia University	1-800-344-9881
WVU Community & Technical College	1-888-442-3000
WVU Institute of Technology	1-888-554-8324
WVU of Parkersburg	1-800-WVA-WVUP

### State Private Colleges & Universities:

Alderson-Broaddus College	1-800-263-1549
Appalachian Bible College	1-800-678-9ABC
Bethany College	1-800-922-7611
Davis & Elkins College	1-800-624-3157
Mountain State College	1-800-841-0201
Ohio Valley College	1-877-446-8668
Salem International	1-888-235-5024
University of Charleston	1-800-995-4682
West Virginia Junior College	1-800-924-5208
West Virginia Wesleyan College	1-800-722-9933
Wheeling Jesuit University	1-800-624-6992

## Capitol Phone Numbers

### SENATE

President's Office	(304) 357-7801
Majority Leader	(304) 357-7808
Minority Leader	(304) 357-7901
Clerk's Office	(304) 357-7800
Journal Room	(304) 357-7947
Education Committee	(304) 357-7952
Finance Committee	(304) 357-7980
Gov. Org. Committee	(304) 357-7935
Judiciary Committee	(304) 357-7880

### HOUSE

Speaker's Office	(304) 340-3210
Majority Leader	(304) 340-3220
Majority Whip	(304) 340-3249
Speaker Pro Tempore	(304) 340-3114
Minority Leader	(304) 340-3240
Clerk's Office	(304) 340-3200
Journal Room	(304) 340-3244
Stenographic Pool	(304) 340-3105
Education Committee	(304) 340-3265
Finance Committee	(304) 340-3230
Gov. Org. Committee	(304) 340-3192
Judiciary Committee	(304) 340-3252

### JOINT COMMITTEE OFFICES

Legislative Services	(304) 347-4800
Bill Drafting	(304) 347-4800
Budget Division	(304) 347-4870
Postaudit Division	(304) 347-4880
PERD	(304) 347-4890
Reference & Information	(304) 347-4836
Legislative Library	(304) 347-4830
Court of Claims	(304) 347-4851
Crime Victims	(304) 347-4850
LASD	(304) 347-4820
Redistricting	(304) 347-4824
Duplicating	(304) 347-4810

## State Agencies - Website Addresses

Air Quality Board: [www.wvaqb.org](http://www.wvaqb.org)  
Alcohol Beverage Control Administration: [www.wvabca.wv.gov](http://www.wvabca.wv.gov)  
Attorney General's Office: [www.wvago.us](http://www.wvago.us)  
Auditor's Office: [www.wvsao.gov](http://www.wvsao.gov)  
Board of Risk & Insurance Management: [www.state.wv.us/brim](http://www.state.wv.us/brim)  
Budget Office, State: [www.budget.wv.gov](http://www.budget.wv.gov)  
Bureau for Behavioral Health & Health Facilities: [www.wvdhhr.org/bhbf](http://www.wvdhhr.org/bhbf)  
Bureau of Child Support Enforcement: [www.wvdhhr.org/bcse](http://www.wvdhhr.org/bcse)  
Bureau of Children & Families: [www.wvdhhr.org/bcf](http://www.wvdhhr.org/bcf)  
Department of Commerce: [www.boc.state.wv.us](http://www.boc.state.wv.us)  
Bureau of Employment Programs: [www.wvbep.org/bep/](http://www.wvbep.org/bep/)  
Bureau of Medical Services: [www.wvdhhr.org/bms](http://www.wvdhhr.org/bms)  
Bureau of Public Health: [www.wvdhhr.org/bph](http://www.wvdhhr.org/bph)  
Bureau of Senior Services: [www.state.wv.us/seniorservices](http://www.state.wv.us/seniorservices)  
Center for Professional Development: [www.wvcpd.org](http://www.wvcpd.org)  
Department of Administration: [www.state.wv.us/admin](http://www.state.wv.us/admin)  
Department of Agriculture: [www.wvagriculture.org](http://www.wvagriculture.org)  
Department of Education & the Arts: [www.wvosea.org](http://www.wvosea.org)  
Department of Education: <http://wvde.state.wv.us>  
Department of Environmental Protection: [www.wvdep.org](http://www.wvdep.org)  
Department of Health & Human Resources: [www.wvdhhr.org](http://www.wvdhhr.org)  
Department of Revenue: [www.wvrevenue.gov](http://www.wvrevenue.gov)  
Department of Transportation: [www.wvdot.com](http://www.wvdot.com)  
Division of Banking: [www.wvdob.org](http://www.wvdob.org)  
Division of Corrections: [www.wvdoc.com/wvdoc](http://www.wvdoc.com/wvdoc)  
Division of Criminal Justice Services: [www.wvdcjs.com](http://www.wvdcjs.com)  
Division of Culture and History: [www.wvculture.org](http://www.wvculture.org)  
Division of Forestry: [www.wvforestry.com](http://www.wvforestry.com)  
Division of Juvenile Services: [www.wvdjs.state.wv.us](http://www.wvdjs.state.wv.us)  
Division of Labor: [www.wvlabor.org](http://www.wvlabor.org)  
Division of Natural Resources: [www.wvdnr.org](http://www.wvdnr.org)  
Division of Personnel: [www.state.wv.us/admin/personnel](http://www.state.wv.us/admin/personnel)  
Division of Tourism: [www.wvtourism.com](http://www.wvtourism.com)  
Division of Veterans Affairs: [www.wvs.state.wv.us/va](http://www.wvs.state.wv.us/va)  
Education & State Employees Grievance Board: [www.state.wv.us/admin/grievanc/decision/](http://www.state.wv.us/admin/grievanc/decision/)

Educational Broadcasting Authority: [www.wvpubcast.org](http://www.wvpubcast.org)  
Environmental Quality Board: [www.wveqb.org](http://www.wveqb.org)  
Equal Employment Opportunity Office: [www.wvf.state.wv.us/eeo](http://www.wvf.state.wv.us/eeo)  
Fire Commission: [www.firemarshal.wv.gov](http://www.firemarshal.wv.gov)  
Geological & Economic Survey: [www.wvgs.wvnet.edu](http://www.wvgs.wvnet.edu)  
Governor's Office: [www.wvgov.org](http://www.wvgov.org)  
Governor's Office of Technology: [www.state.wv.us/got](http://www.state.wv.us/got)  
Health Care Authority: [www.hcawv.org](http://www.hcawv.org)  
Higher Education Policy Commission: [www.hepc.wvnet.edu](http://www.hepc.wvnet.edu)  
House of Delegates: [www.legis.state.wv.us](http://www.legis.state.wv.us)  
Housing Development Fund: [www.wvhdf.com](http://www.wvhdf.com)  
Human Rights Commission: [www.wvf.state.wv.us/wvhrc](http://www.wvf.state.wv.us/wvhrc)  
Insurance Commission: [www.wvinsurance.gov](http://www.wvinsurance.gov)  
Investment Management Board: [www.wvimb.org](http://www.wvimb.org)  
Jobs Investment Trust: [www.wvjit.org](http://www.wvjit.org)  
Legislative Services: [www.legis.state.wv.us](http://www.legis.state.wv.us)  
Library Commission: [www.librarycommission.lib.wv.us](http://www.librarycommission.lib.wv.us)  
Lottery Commission: [www.wvlottery.com](http://www.wvlottery.com)  
Miners' Health Safety & Training: [www.wvminesafety.org](http://www.wvminesafety.org)  
Division of Homeland Security & Emergency Management: [www.wvdhsem.gov](http://www.wvdhsem.gov)  
Parkways, Economic Development & Tourism: [www.wvturnpike.com](http://www.wvturnpike.com)  
Public Defender Services: [www.wvpds.org](http://www.wvpds.org)  
Public Employees Insurance Agency: [www.westvirginia.com/peia](http://www.westvirginia.com/peia)  
Public Service Commission: [www.psc.state.wv.us](http://www.psc.state.wv.us)  
Purchasing Division: [www.state.wv.us/admin/purchase](http://www.state.wv.us/admin/purchase)  
Racing Commission: [www.wvracingcommission.gov](http://www.wvracingcommission.gov)  
Real Estate Commission: [www.wvrec.org](http://www.wvrec.org)  
Rehabilitation Services: [www.wvdrs.org](http://www.wvdrs.org)  
Secretary of State: [www.wvsos.com](http://www.wvsos.com)  
Senate: [www.legis.state.wv.us](http://www.legis.state.wv.us)  
Solid Waste Management Board: [www.state.wv.us/swmb](http://www.state.wv.us/swmb)  
State Bar: [www.wvbar.org](http://www.wvbar.org)  
Supreme Court of Appeals: [www.state.wv.us/wvsca](http://www.state.wv.us/wvsca)  
Tax Department, State: [www.wvtax.gov](http://www.wvtax.gov)

## State Agencies - Website Addresses (con't)

Treasurer's Office: [www.wvsto.com](http://www.wvsto.com)

Water Development Authority: [www.wvwda.org](http://www.wvwda.org)

West Virginia State Police: [www.wvstatepolice.com](http://www.wvstatepolice.com)

Women's Commission: [www.wvdhhr.org/women](http://www.wvdhhr.org/women)

Worker's Compensation Commission: [www.wvinsurance.gov/wc](http://www.wvinsurance.gov/wc)

WV Board of Medicine: [www.wvdhhr.org/wvbom](http://www.wvdhhr.org/wvbom)

WV Network-Educational Telecomputing: [www.wvnet.edu](http://www.wvnet.edu)

WV Public Employees Credit Union: [www.wvpecu.org](http://www.wvpecu.org)

## State Government - Website Addresses

**West Virginia State Portal**

[www.wv.gov](http://www.wv.gov)

**West Virginia Legislature**

[www.legis.state.wv.us](http://www.legis.state.wv.us)

**Supreme Court of Appeals**

[www.state.wv.us/wvsca](http://www.state.wv.us/wvsca)

## Political Organizations - Website Addresses

**National Conference of State Legislatures (NCSL)**

[www.ncsl.org](http://www.ncsl.org)

**Council of State Governments (CSG)**

[www.csg.org](http://www.csg.org)

**Southern Legislative Conference (SLC)**

[www.slcatlanta.org](http://www.slcatlanta.org)

**National Governor's Association**

[www.nga.org](http://www.nga.org)

**Democratic National Committee**

[www.democrats.org](http://www.democrats.org)

**Republican National Committee**

[www.gop.org](http://www.gop.org)

**WV State Democratic Party**

[www.wvdemocrats.com](http://www.wvdemocrats.com)

**WV Republican State Committee**

[www.wvgop.org](http://www.wvgop.org)

## State Public Colleges & Universities - Website Addresses

<b>Bluefield State College</b>	<a href="http://www.bluefieldstate.edu">http://www.bluefieldstate.edu</a>
<b>Blue Ridge Community and Technical College</b>	<a href="http://www.blueridgectc.edu">http://www.blueridgectc.edu</a>
<b>Concord University</b>	<a href="http://www.concord.edu">http://www.concord.edu</a>
<b>Eastern WV Community &amp; Technical College</b>	<a href="http://www.eastern.wvnet.edu">http://www.eastern.wvnet.edu</a>
<b>Fairmont State Community &amp; Technical College</b>	<a href="http://www.fairmontstate.edu">http://www.fairmontstate.edu</a>
<b>Fairmont State University</b>	<a href="http://www.fairmontstate.edu">http://www.fairmontstate.edu</a>
<b>Glenville State College</b>	<a href="http://www.glenville.edu">http://www.glenville.edu</a>
<b>Marshall University</b>	<a href="http://www.marshall.edu">http://www.marshall.edu</a>
<b>Mountwest Community &amp; Technical College</b>	<a href="http://www.mctc.edu">http://www.mctc.edu</a>
<b>New River Community &amp; Technical College</b>	<a href="http://www.newriver.edu">http://www.newriver.edu</a>
<b>Potomac State College</b>	<a href="http://www.potomacstatecollege.edu">http://www.potomacstatecollege.edu</a>
<b>Shepherd University</b>	<a href="http://www.shepherd.edu">http://www.shepherd.edu</a>
<b>Southern WV Community &amp; Technical College</b>	<a href="http://www.southernwv.edu">http://www.southernwv.edu</a>
<b>West Liberty State College</b>	<a href="http://www.westliberty.edu">http://www.westliberty.edu</a>
<b>West Virginia Northern Community College</b>	<a href="http://www.wvncc.edu">http://www.wvncc.edu</a>
<b>West Virginia School of Osteopathic Medicine</b>	<a href="http://www.wvsom.edu">http://www.wvsom.edu</a>
<b>West Virginia State Community &amp; Technical College</b>	<a href="http://www.wvsctc.edu">http://www.wvsctc.edu</a>
<b>West Virginia State University</b>	<a href="http://www.wvstateu.edu">http://www.wvstateu.edu</a>
<b>West Virginia University</b>	<a href="http://www.wvu.edu">http://www.wvu.edu</a>
<b>WVU Institute of Technology</b>	<a href="http://www.wvutech.edu">http://www.wvutech.edu</a>
<b>WVU of Parkersburg</b>	<a href="http://www.wvup.edu">http://www.wvup.edu</a>

## State Private Colleges & Universities - Website Addresses

<b>Alderson-Broaddus College</b>	<a href="http://www.ab.edu">http://www.ab.edu</a>
<b>Appalachian Bible College</b>	<a href="http://www.abc.edu">http://www.abc.edu</a>
<b>Bethany College</b>	<a href="http://www.bethanywv.edu">http://www.bethanywv.edu</a>
<b>Davis &amp; Elkins College</b>	<a href="http://www.davisandelkins.edu">http://www.davisandelkins.edu</a>
<b>Mountain State College</b>	<a href="http://www.mountainstate.edu">http://www.mountainstate.edu</a>
<b>Ohio Valley College</b>	<a href="http://www.ovc.edu">http://www.ovc.edu</a>
<b>Salem International</b>	<a href="http://www.salemu.edu">http://www.salemu.edu</a>
<b>University of Charleston</b>	<a href="http://www.ucwv.edu">http://www.ucwv.edu</a>
<b>West Virginia Junior College</b>	<a href="http://www.jcchas.net">http://www.jcchas.net</a>
<b>West Virginia Wesleyan College</b>	<a href="http://www.wvwc.edu">http://www.wvwc.edu</a>
<b>Wheeling Jesuit University</b>	<a href="http://www.wju.edu">http://www.wju.edu</a>





## United States Senate

### The Honorable John D. Rockefeller IV

United States Senate  
531 Hart Building  
Washington, D.C. 20510  
Tel: (202) 224-6472  
Fax: (202) 224-7665  
E-mail: senator@rockefeller.senate.gov

Charleston Office  
405 Capitol Street, Suite 508  
Charleston, WV 25301  
Tel: (304) 347-5372  
Fax: (304) 347-5371

Martinsburg Office  
217 W. King St., Suite 307  
Martinsburg, WV 25401  
Tel: (304) 262-9285  
Fax: (304) 262-9288

Beckley Office  
207 Prince Street  
Beckley, WV 25801  
Tel: (304) 253-9704

Fairmont Office  
118 Adams Street, Suite 301  
Fairmont, WV 26554  
Tel: (304) 367-0122  
Fax: (304) 367-0822

### The Honorable Joe Manchin III

311 Hart Senate Office Building  
Washington DC, 20510  
Phone: 202-224-3954  
Fax: 202-228-0002  
E-mail: senator\_manchin@manchin.senate.gov

Charleston Office  
300 Virginia Street East, Suite 2630  
Charleston, WV 25301  
Phone: 304-342-5855  
Fax: 304-343-7144

Eastern Panhandle Office  
217 West King Street, Room 238  
Martinsburg, WV 25401  
Phone: 304-264-4626  
Fax: 304-262-3039

## United States House of Representatives

### 1st District

#### The Honorable David McKinley

U.S. House of Representatives  
313 Cannon House Office Building  
Washington, D.C. 20515

Tel: (202) 225-4172  
Fax: (202) 225-7564  
E-mail: repmckinley@mail.house.gov



Wheeling Office  
Federal Building  
1125 Chapline Street  
Wheeling, WV 26003  
Tel: (304) 232-3801  
Fax: (304) 232-3813

Morgantown Office  
709 Beechurst Avenue, Suite 14-B  
Morgantown, WV 26505  
Tel: (304) 284-8506  
Fax: (304) 284-8505

Parkersburg Office  
Federal Building, Suite 1004  
425 Juliana Street  
Parkersburg, WV 26101  
Tel: (304) 422-5972  
Fax: (304) 422-5974

### 2nd District

#### The Honorable Shelley Moore Capito

U.S. House of Representative  
2443 Rayburn House Office Building  
Washington, D.C 20515

Tel: (202) 225-2711  
Fax: (202) 225-7856



Charleston Office  
4815 MacCorkle Ave. SE  
Charleston, WV 25304  
Tel: (304) 925-5964  
Fax: (304) 926-8912

Martinsburg Office  
300 Foxcraft Ave., Suite 102  
Martinsburg, WV 25401  
Tel: (304) 264-8810  
Fax: (304) 264-8815

### 3rd District

#### The Honorable Nick J. Rahall

U.S. House of Representatives  
2307 Rayburn House Office Building  
Washington, D.C. 20515

Tel: (202) 225-3452  
E-mail: nrahall@mail.house.gov



Beckley Office  
301 Prince St.  
Beckley, WV 25801  
Tel: (304) 252-5000  
Fax: (304) 252-9803

Bluefield Office  
601 Federal St., Rm 1005  
Bluefield, WV 24701  
Tel: (304) 325-6222  
Fax: (304) 325-0552

Huntington Office  
845 5th Ave.  
Huntington, WV 25701  
Tel: (304) 522-6425  
Fax: (304) 529-5716

Lewisburg Office  
P.O. Box 5  
101 North Court Street  
Lewisburg, WV 24901  
Tel: (304) 647-3228  
Fax: (304) 647-3304

Logan Office  
220 Dingess St.  
Logan, WV 25601  
Tel: (304) 752-4934  
Fax: (304) 752-8797

# 2012 Legislative Calendar

## January

Sun	Mon	Tue	Wed	Thu	Fri	Sat
1	2	3	4	5	6	7
8	9	10	11	12	13	14
15	16	17	18	19	20	21
22	23	24	25	26	27	28
29	30	31				

**First Day** - January 11, 2012: First day of session. (*WV Const. Art. VI, §18*)

**Twentieth Day** - January 30, 2012: Submission of Legislative Rule-Making Review bills due. (*WV Code §29A-3-12*)

**Forty-first Day** - February 20, 2012: Last day to introduce bills in the Senate and the House. (*Senate Rule 14, House Rule 91a*) Does not apply to originating or supplementary appropriation bills. Does not apply to Senate or House resolutions or concurrent resolutions.

**Forty-seventh Day** - February 26, 2012: Bills due out of committees in house of origin to ensure three full days for readings.

**Fiftieth Day** - February 29, 2012: Last day to consider bill on third reading in house of origin. Does not include budget or supplementary appropriation bills. (*Joint Rule 5b*)

**Sixtieth Day** - March 10 2010: Adjournment at Midnight. (*WV Const. Art. VI, §22*)

## February

Sun	Mon	Tue	Wed	Thu	Fri	Sat
			1	2	3	4
5	6	7	8	9	10	11
12	13	14	15	16	17	18
19	20	21	22	23	24	25
26	27	28	29			

## March

Sun	Mon	Tue	Wed	Thu	Fri	Sat
				1	2	3
4	5	6	7	8	9	10
11	12	13	14	15	16	17
18	19	20	21	22	23	24
25	26	27	28	29	30	31

 = legislative session

 = legislative landmark